

Tri-Clamp Fittings

BS6362 Schedule 5, Ferrules

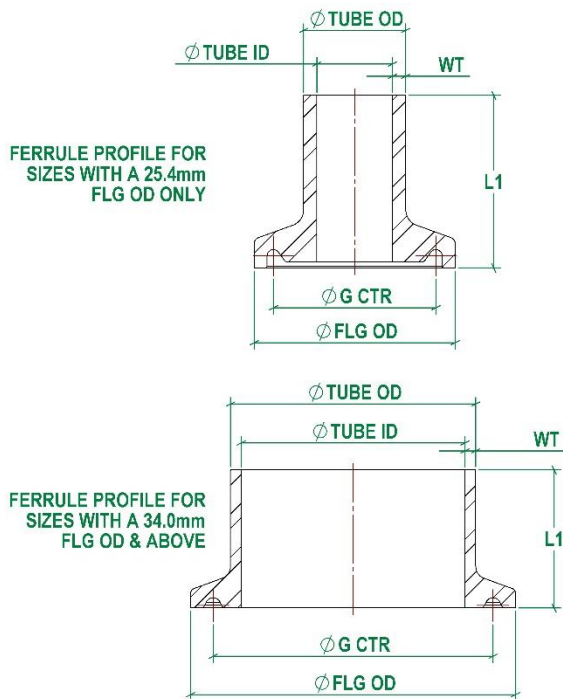

- Standard:** BS6362 Schedule 5
- Material:** 316 Stainless Steel, EN1.4401
- Certification:** EN 10204-3.1
- Surface Finish (Internal):** 0.8Ra On Flat Surfaces
- Associated Standard:** ASME/ANSI B36.10M
- Associated Parts:** TC Clamps, TC Ferrules & TC Gaskets
- Options:** Duplex Materials Available Bored Upon Request
- Remarks:** Non-Standard Lengths Available Upon Request

TC Fittings, TC Ferrule, Schedule 5							
Size (Inch / Nominal Bore)	FLG OD (mm)	TUBE OD (mm)	TUBE ID (mm)	WT (mm)	G CTR (mm)	L1 (mm)	Part Code
0.500"	50.50	21.34	18.04	1.65	43.50	21.50	CF.S05.0050.6
0.750"	50.50	26.67	23.37	1.65	43.50	21.50	CF.S05.0075.6
1.000"	50.50	33.40	30.10	1.65	43.50	21.50	CF.S05.0100.6
1.250"	64.00	42.16	38.86	1.65	56.50	21.50	CF.S05.0125.6
1.500"	64.00	48.26	44.96	1.65	56.50	21.50	CF.S05.0150.6
2.000"	77.50	60.32	57.02	1.65	70.50	21.50	CF.S05.0200.6
2.500"	91.00	73.02	68.80	2.11	83.50	21.50	CF.S05.0250.6
3.000"	106.00	88.90	84.68	2.11	97.00	21.50	CF.S05.0300.6
4.000"	130.00	114.30	110.08	2.11	122.00	28.00	CF.S05.0400.6
5.000"	155.00	141.30	135.76	2.77	146.00	28.00	CF.S05.0500.6
6.000"	183.00	168.27	162.73	2.77	174.00	28.00	CF.S05.0600.6
8.000"	233.50	219.07	213.53	2.77	225.00	28.00	CF.S05.0800.6
10.000"	286.10	273.05	266.25	3.40	276.00	28.00	CF.S05.1000.6
12.000"	338.00	323.85	315.93	3.96	329.00	28.00	CF.S05.1200.6

Published Data Is Given in Good Faith. We Reserve the Right To, Without Warning Change the Dimensions When Not In Conflict With The Published Standard