

ASME BPE Fittings

DT-4.1.1-3 (DT16) 90° Bends, Clamp Ended

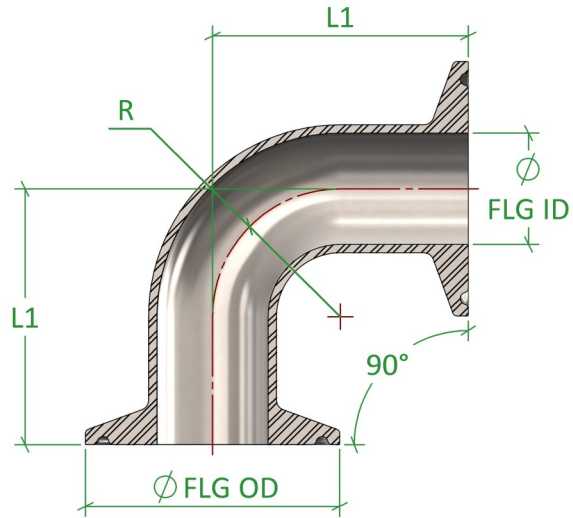

Standard	ASME BPE 2016	Certification	EN10204 3.1
Connections	TC Ferrule Ended	Associated Parts	DT22 TC Ferrules
Material	316L Stainless Steel EN 1.4404	Associated Standards	ASME BPE 2009, 2012
Surface Finish	SF1—0.51Ra µm Max	Options	SF4—0.38Ra µm Max E/Polished On Request
Remarks			

ASME BPE Fittings, DT-4.1.1-3 (DT16) 90° Bends, TC Ended

Size (inch)	FLG OD (mm)	FLG ID (mm)	R (mm)	L1 (mm)	Part Code
0.500"	25.40	9.40	19.05	41.28	BPE.DT16.0050.SF1
0.750"	25.40	15.75	28.58	41.28	BPE.DT16.0075.SF1
1.000"	50.50	22.10	38.10	50.80	BPE.DT16.0100.SF1
1.500"	50.50	34.80	57.15	69.85	BPE.DT16.0150.SF1
2.000"	64.00	47.50	76.20	88.90	BPE.DT16.0200.SF1
2.500"	77.50	60.20	95.25	107.95	BPE.DT16.0250.SF1
3.000"	91.00	72.90	114.30	127.00	BPE.DT16.0300.SF1
4.000"	119.00	97.38	152.40	168.28	BPE.DT16.0400.SF1
6.000"	167.00	146.86	228.60	266.70	BPE.DT16.0600.SF1

Published Data Is Given in Good Faith. We Reserve the Right To, Without Warning Change the Dimensions When Not In Conflict With The Published Standard

Flowsource Process Fittings Ltd

Unit 4 Marrtree Business Park, Cedar Road, Sowerby, Thirsk, North Yorkshire, YO7 3FF, United Kingdom
 [T] 01535 274 316 - [e] sales@flowsourcepf.com - [w] www.flowsourcepf.com

FLWSOURCE
PROCESS FITTINGS